

FLOAT

Design MAURICIO BOMFIM





OS TAMAÑOS DAS ALMOFADAS DA IMAGEM NÃO CORRESPONDEM ÀS MEDIDAS PADRÕES DO PRODUTO. AS DIMENSÕES REAIS PODEM SER VERIFICADAS NA LISTA DE CONFIGURAÇÕES.

DESCRIÇÃO DO PRODUTO

ASSENTO: FIXO - PERCINTA + HR + D33 + D26 ULTRACEL + FIBRA.

ENCOSTO: FIXO - HR + D20 SOFT + D26 ULTRACEL + FIBRA.

ALMOFADA DE ENCOSTO: SOLTA + D26 ULTRACEL + FIBRA.

ALMOFADA DECORATIVA: SOLTA + D26 ULTRACEL + FIBRA.

ALMOFADA DE RIM: SOLTA + D26 ULTRACEL + FIBRA.

BASE: : PINTURA ELETROSTÁTICA - CHUMBO, BLACK, OFF WHITE OU CHOCOLATE

PINTURA LÍQUIDA - PLATINUS, CHAMPAGNE OU CHUMBO METALIZADO

MESA: LÂMINA NATURAL - CARVALHO NATURAL, CARVALHO EBANIZADO, CARVALHO LINEN OU NOGUEIRA. TINGIMENTO - TINGIMENTO NATURAL, EBANIZADO, LINEN, NOGUEIRA, NOZES OU IMBUIA.

GAVETÃO: LÂMINA NATURAL - CARVALHO NATURAL, CARVALHO EBANIZADO, CARVALHO LINEN OU NOGUEIRA.

TINGIMENTO - TINGIMENTO NATURAL, EBANIZADO, LINEN, NOGUEIRA, NOZES OU IMBUIA.

OPCIONAIS: CARREGADOR USB NO BRAÇO (CABO DE ALIMENTAÇÃO PARA TOMADA PADRÃO DO BRASIL OU EUA).

OBSERVAÇÕES: A MESA CONTÉM 30CM DE LARGURA, PORÉM, APLICADA AO PRODUTO ELA OCUPA UM ESPAÇO DE 20CM NA CONFIGURAÇÃO FINAL.

THE SIZES OF THE PILLOWS IN THE IMAGE DO NOT CORRESPOND TO THE STANDARD MEASUREMENTS OF THE PRODUCT. ACTUAL DIMENSIONS CAN BE CHECKED IN THE CONFIGURATION LIST.

DESCRIPTION OF PRODUCT

SEAT: FIXED - ELASTIC BELT + HR + D33 + D26 ULTRACEL + FIBER.

BACKREST: FIXED - HR + D20 SOFT + D26 ULTRACEL + FIBER.

BACKREST CUSHION: LOOSE + D26 ULTRACEL + FIBER.

DECORATIVE CUSHION: LOOSE + D26 ULTRACEL + FIBER.

LUMBAR CUSHION: LOOSE + D26 ULTRACEL + FIBER.

BASE: : ELECTROSTATIC COATING - LEAD, BLACK, OFF WHITE OR CHOCOLATE LIQUID COATING - PLATINUS, CHAMPAGNE OR METALLIC-LEAD

TABLE: NATURAL VENEER - NATURAL OAK, EBANIZED OAK, OAK LINEN OR WALNUT.

DYEING - NATURAL DYED, EBANIZED, LINEN, WALNUT OR IMBUIA.

INVOLVING STRUCTURE: NATURAL VENEER - NATURAL OAK, EBANIZED OAK, OAK LINEN OR WALNUT.

DYEING - NATURAL DYED, EBANIZED, LINEN, WALNUT, WALNUT, OR IMBUIA.

OPTIONAL: USB CHARGER IN THE ARMREST (POWER CORD TO STANDARD BRAZIL OR US OUTLET).

NOTE: THE TABLE CONTAINS 30CM WIDTH, HOWEVER, APPLIED TO THE PRODUCT IT OCCUPIES A SPACE OF 20CM IN THE FINAL CONFIGURATION.



LOS TAMAÑOS DE LAS ALMOHADAS DE LA IMAGEN NO SE CORRESPONDEN CON LAS MEDIDAS ESTÁNDAR DEL PRODUCTO. LAS DIMENSIONES REALES SE PUEDEN COMPROBAR EN LA LISTA DE CONFIGURACIÓN

DESCRIPCIÓN DEL PRODUCTO

ASIENTO: FIJO - CINTURÓN ELÁSTICO + HR + D33 + D26 ULTRACEL + FIBRA.

RESPALDO: FIJO - HR + D20 BLANDO + D26 ULTRACEL + FIBRA.

ALMOHADA DE RESPALDO: SUELTO + D26 ULTRACEL + FIBRA.

ALMOHADA DECORATIVA: SUELTA + D26 ULTRACEL + FIBRA.

ALMOHADA ESPALDA BAJA: SUELTO + D26 ULTRACEL + FIBRA.

BASE: PINTURA ELETROSTÁTICA - PLOMO, NEGRO, OFF WHITE O CHOCOLATE

PINTURA LÍQUIDA - PLATINUS, CHAMPÁN O PLOMO METÁLICO

MESA: CHAPA NATURAL - ROBLE NATURAL, ROBLE EBANIZADO, ROBLE LINO O NOGAL.

TEÑIDO - TINTE NATURAL, EBANIZADO, LINO, NOGAL O IMBUIA. C17

CAJÓN: CHAPA NATURAL - ROBLE NATURAL, ROBLE EBANIZADO, ROBLE LINO O NOGAL.

TINTE - TINTE NATURAL, EBANIZADO, LINO, NOGAL, NUEZ O IMBUIA.

OPCIONAL: CARGADOR USB EN EL BRAZO (CABLE DE ALIMENTACIÓN A ENCHUFE ESTÁNDAR EN BRASIL O EE. UU.).

OBSERVACIONES: LA MESA CONTIENE 30CM DE ANCHO, SIN EMBARGO, APLICADA AL PRODUCTO OCUPA UN ESPACIO DE 20CM EN LA CONFIGURACIÓN FINAL.

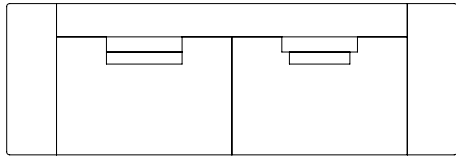

Configurações com 2 assentos e 2 braços

Módulo 208 - 2ass(71) + 2br(33) + 2alm/enc(55x50) + 1alm/dec(40x40) + 1alm/rim(50x30)
 Módulo 238 - 2ass(86) + 2br(33) + 2alm/enc(70x50) + 1alm/dec(40x40) + 1alm/rim(50x30)
 Módulo 268 - 2ass(101) + 2br(33) + 2alm/enc(85x50) + 1alm/dec(40x40) + 1alm/rim(50x30)
 Módulo 298 - 2ass(116) + 2br(33) + 2alm/enc(100x50) + 1alm/dec(40x40) + 1alm/rim(50x30)

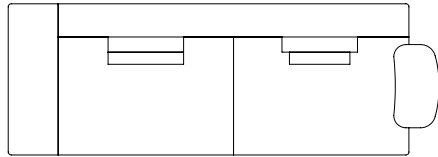

Configurações com 2 assentos, 1 braço e 1 mesa

Módulo 195 - 2ass(71) + 1br(33) + 1mesa(30) + 2alm/enc(55x50) + 1alm/dec(40x40) + 1alm/rim(50x30)
 Módulo 225 - 2ass(86) + 1br(33) + 1mesa(30) + 2alm/enc(70x50) + 1alm/dec(40x40) + 1alm/rim(50x30)
 Módulo 255 - 2ass(101) + 1br(33) + 1mesa(30) + 2alm/enc(85x50) + 1alm/dec(40x40) + 1alm/rim(50x30)
 Módulo 285 - 2ass(116) + 1br(33) + 1mesa(30) + 2alm/enc(100x50) + 1alm/dec(40x40) + 1alm/rim(50x30)

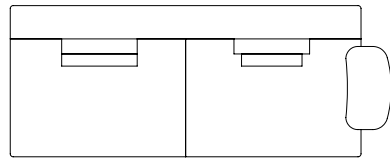

Configurações com 2 assentos e 1 mesa

Módulo 162 - 2ass(71) + 1mesa(30) + 2alm/enc(55x50) + 1alm/dec(40x40) + 1alm/rim(50x30)
 Módulo 192 - 2ass(86) + 1mesa(30) + 2alm/enc(70x50) + 1alm/dec(40x40) + 1alm/rim(50x30)
 Módulo 222 - 2ass(101) + 1mesa(30) + 2alm/enc(85x50) + 1alm/dec(40x40) + 1alm/rim(50x30)
 Módulo 252 - 2ass(116) + 1mesa(30) + 2alm/enc(100x50) + 1alm/dec(40x40) + 1alm/rim(50x30)

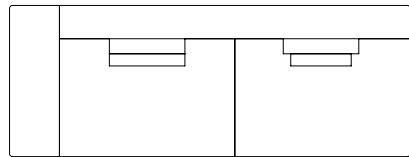

Configurações com 2 assentos e 1 braço

Módulo 175 - 2ass(71) + 1br(33) + 2alm/enc(55x50) + 1alm/dec(40x40) + 1alm/rim(50x30)
 Módulo 205 - 2ass(86) + 1br(33) + 2alm/enc(70x50) + 1alm/dec(40x40) + 1alm/rim(50x30)
 Módulo 235 - 2ass(101) + 1br(33) + 2alm/enc(85x50) + 1alm/dec(40x40) + 1alm/rim(50x30)
 Módulo 265 - 2ass(116) + 1br(33) + 2alm/enc(100x50) + 1alm/dec(40x40) + 1alm/rim(50x30)

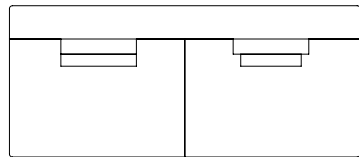

Configurações com 2 assentos e sem braço

Módulo 142 - 2ass(71) + 2alm/enc(55x50) + 1alm/dec(40x40) + 1alm/rim(50x30)
 Módulo 172 - 2ass(86) + 2alm/enc(70x50) + 1alm/dec(40x40) + 1alm/rim(50x30)
 Módulo 202 - 2ass(101) + 2alm/enc(85x50) + 1alm/dec(40x40) + 1alm/rim(50x30)
 Módulo 232 - 2ass(116) + 2alm/enc(100x50) + 1alm/dec(40x40) + 1alm/rim(50x30)

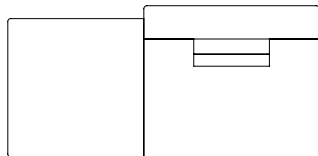

Configurações com 1 assento e 1 mesa

Módulo 161 - 1ass(71) + 1mesa(90) + 2alm/enc(55x50) + 1alm/rim(50x30)
 Módulo 176 - 1ass(86) + 1mesa(90) + 2alm/enc(70x50) + 1alm/rim(50x30)
 Módulo 191 - 1ass(101) + 1mesa(90) + 2alm/enc(85x50) + 1alm/rim(50x30)
 Módulo 206 - 1ass(116) + 1mesa(90) + 2alm/enc(100x50) + 1alm/rim(50x30)

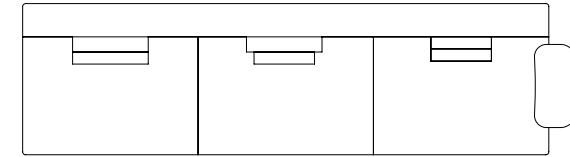
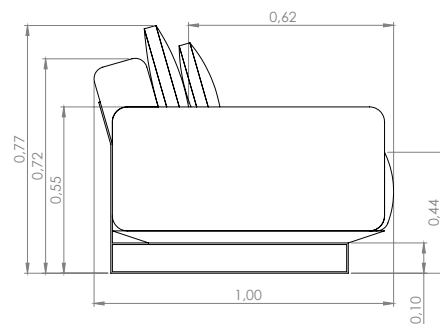

Configuração com 3 assentos e 1 mesa

Módulo 323 - 3ass(101) + 1mesa(30) + 3alm/enc(85x50) + 2alm/dec(40x40) + 1alm/rim(50x30)

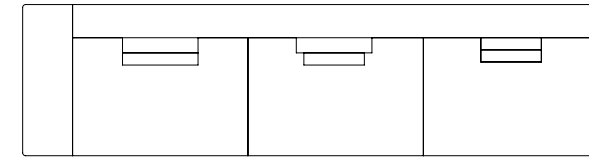

Configuração com 3 assentos e 1 braço

Módulo 336 - 3ass(101) + 1br(33) + 3alm/enc(85x50) + 2alm/dec(40x40) + 1alm/rim(50x30)

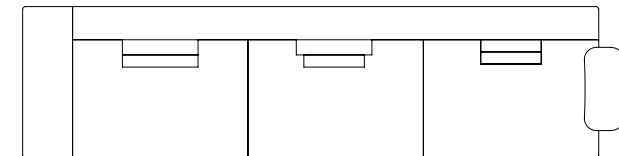

Configuração com 3 assentos, 1 braço e 1 mesa

Módulo 356 - 3ass(101) + 1br(33) + 1mesa(30) + 3alm/enc(85x50) + 2alm/dec(40x40) + 1alm/rim(50x30)

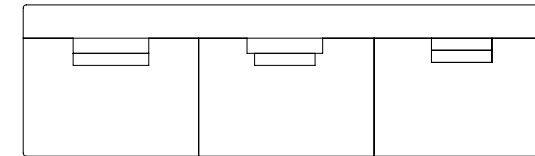

Configuração com 3 assentos e sem braço

Módulo 303 - 3ass(101) + 3alm/enc(85x50) + 2alm/dec(40x40) + 1alm/rim(50x30)

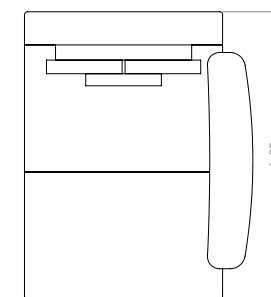

Configurações de Chaise

Chaise 121 - 1ass(101) + 1mesa(30) + 1alm/enc(90x50) + 2alm/dec(40x40) + 1alm/rim(50x30)
 Chaise 151 - 1ass(131) + 1mesa(30) + 1alm/enc(90x50) + 2alm/dec(40x40) + 1alm/rim(50x30)

