

SENNA

Design MAURICIO BOMFIM



ASSISTA O
CONCEITO
DESTE
PRODUTO

DESCRIÇÃO DO PRODUTO

ASSENTO: FIXO – PERCINTA + HR + ULTRACEL + FIBRA

ENCOSTO: FIXO - HR + FIBRA

ALMOFADA DE ENCOSTO: SOLTA - FIBRA SILICONADA + FIBRA

ALMOFADA DE RIM: SOLTA – ULTRACEL + FIBRA

PÉ: PRETO

MESA: LÂMINA NATURAL - CARVALHO NATURAL, CARVALHO EBANIZADO, CARVALHO LINEN OU NOGUEIRA.

OBSERVAÇÕES: MÓDULOS CHAISE E BRAÇO PUFF (55) TERÃO UMA COSTURA NO ASSENTO DEVIDO A LARGURA MÁXIMA DO TECIDO.

DESCRIPTION OF PRODUCT

SEAT: FIXED – ELASTIC BELT + HR + ULTRACEL + FIBER

BACKREST: FIXED – HR + FIBER

BACKREST CUSHION: LOOSE – SILICONE FIBER + FIBER

LUMBAR CUSHION: LOOSE – ULTRACEL + FIBER

FOOT: BLACK

TABLE: NATURAL VENEER - NATURAL OAK, EBANIZED OAK, OAK LINEN OR WALNUT

NOTE: THE CHAISE AND PUFF ARM (55) MODULE HAS A CENTRALIZED SEAM DUE TO THE WIDTH OF THE FABRIC

DESCRIPCIÓN DEL PRODUCTO

ASIENTO: FIJO – CINTURÓN ELÁSTICO+ HR + ULTRACEL + FIBRA

RESPALDO: FIJO - HR + FIBRA

ALMOHADA DE RESPALDO: SUELTO - FIBRA SILICONADA + FIBRA

ALMOHADA ESPALDA BAJA: SUELTO – ULTRACEL + FIBRA

PIE: NEGRO

MESA: CHAPA NATURAL - ROBLE NATURAL, ROBLE EBONIZADO, ROBLE LINO O NOGAL

OBSERVACIONES: EL MÓDULO DE LA CHAISE Y BRAZO PUFF (55) TIENE UNA COSTURA CENTRALIZADA DEBIDO A LA ANCHURA DE LA TELA.

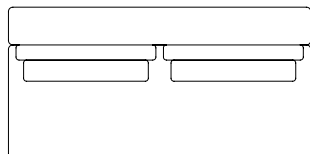

Configurações com 1 assento

Módulo 90 - 1ass(90) + 1alm/enc(70x50) + 1alm/rim(50x42)
Módulo 110 - 1ass(110) + 1alm/enc(90x50) + 1alm/rim(50x42)
Módulo 180 - 1ass(180) + 2alm/enc(70x50) + 2alm/rim(50x42)
Módulo 220 - 1ass(220) + 2alm/enc(90x50) + 2alm/rim(50x42)

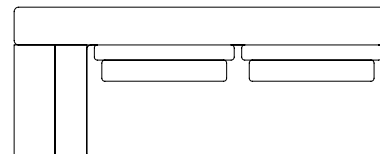

Configurações com 1 assento e 1 braço/mesa

Módulo 138 - 1ass(90) + 1br/mesa(48) + 1alm/enc(70x50) + 1alm/rim(50x42)
Módulo 158 - 1ass(110) + 1br/mesa(48) + 1alm/enc(90x50) + 1alm/rim(50x42)
Módulo 228 - 1ass(180) + 1br/mesa(48) + 2alm/enc(70x50) + 2alm/rim(50x42)
Módulo 268 - 1ass(220) + 1br/mesa(48) + 2alm/enc(90x50) + 2alm/rim(50x42)

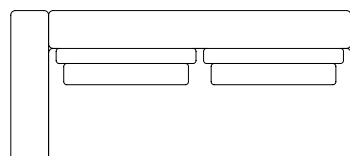

Configurações com 1 assento e 1 braço menor (25)

Módulo 115 - 1ass(90) + 1br(25) + 1alm/enc(70x50) + 1alm/rim(50x42)
Módulo 135 - 1ass(110) + 1br(25) + 1alm/enc(90x50) + 1alm/rim(50x42)
Módulo 205 - 1ass(180) + 1br(25) + 2alm/enc(70x50) + 2alm/rim(50x42)
Módulo 245 - 1ass(220) + 1br(25) + 2alm/enc(90x50) + 2alm/rim(50x42)

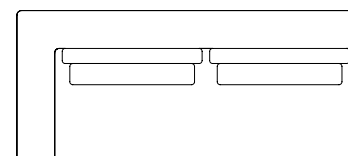

Configurações de Canto com 1 assento

Canto 205 - 1ass(180) + 1br/enc(25) + 2alm/enc(70x50) + 2alm/rim(50x42)
Canto 245 - 1ass(220) + 1br/enc(25) + 2alm/enc(90x50) + 2alm/rim(50x42)

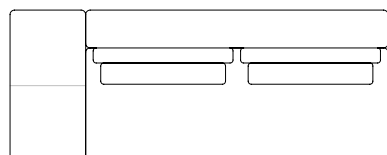

Configurações com 1 assento e 1 braço maior (55)

Módulo 145 - 1ass(90) + 1br(55) + 1alm/enc(70x50) + 1alm/rim(50x42)
Módulo 165 - 1ass(110) + 1br(55) + 1alm/enc(90x50) + 1alm/rim(50x42)
Módulo 235 - 1ass(180) + 1br(55) + 2alm/enc(70x50) + 2alm/rim(50x42)
Módulo 275 - 1ass(220) + 1br(55) + 2alm/enc(90x50) + 2alm/rim(50x42)

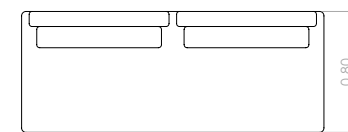

Configurações de 1 assento invertido

Módulo 180 - 1ass(180x80) + 2alm/enc(70x50) + 2alm/rim(50x42)
Módulo 220 - 1ass(220x80) + 2alm/enc(90x50) + 2alm/rim(50x42)

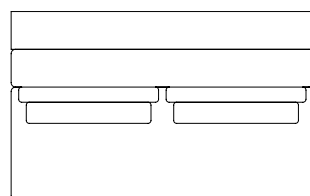

Configurações com 1 assento e 1 mesa no encosto

Módulo 180 - 1ass(180) + 2alm/enc(70x50) + 2alm/rim(50x42)
Módulo 220 - 1ass(220) + 2alm/enc(90x50) + 2alm/rim(50x42)

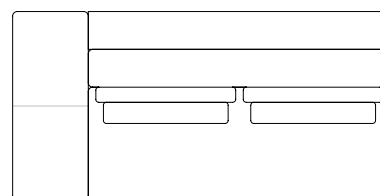

Configurações com 1 assento, 1 braço (55) e 1 mesa no encosto

Módulo 235 - 1ass(180) + 1br(55) + 2alm/enc(70x50) + 2alm/rim(50x42)
Módulo 275 - 1ass(220) + 1br(55) + 2alm/enc(90x50) + 2alm/rim(50x42)

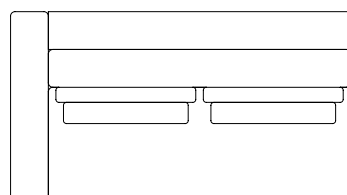

Configurações com 1 assento, 1 braço (25) e 1 mesa no encosto

Módulo 205 - 1ass(180) + 1br(25) + 2alm/enc(70x50) + 2alm/rim(50x42)
Módulo 245 - 1ass(220) + 1br(25) + 2alm/enc(90x50) + 2alm/rim(50x42)



Configuração de braço (55) para assento duplo

Braço 55 - 1br(55x190)



Configurações de Puff

Puff 90 - 1puff(90x80)
Puff 110 - 1puff(110x80)
Puff 180 - 1puff(180x80)
Puff 220 - 1puff(220x80)



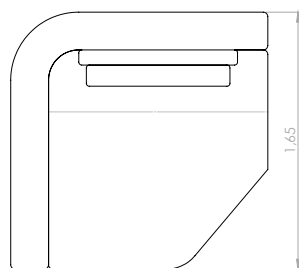

Configurações de Chaise com braço

Chaise 125 - 1ass(100) + 1br(25) + 1alm/enc(80x50) + 1alm/rim(50x42)

Chaise 145 - 1ass(120) + 1br(25) + 1alm/enc(100x50) + 1alm/rim(50x42)

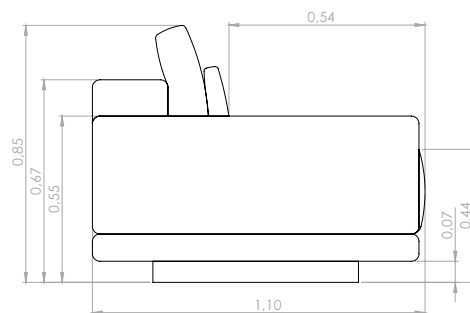

Sofá sem mesa/encosto

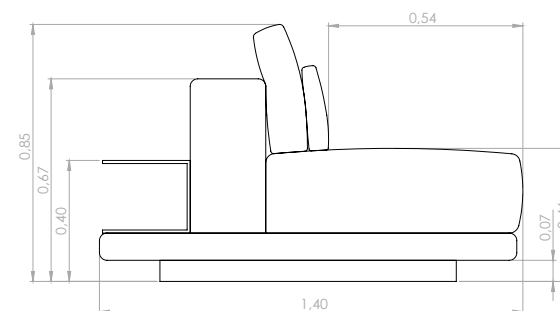

Sofá com mesa/encosto

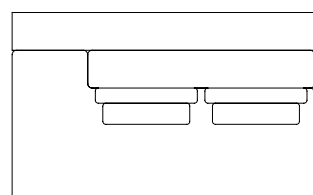

Configurações com 1 assento, 1 puff e 1 mesa no encosto

Módulo 140 - 1ass(90) + 1puff(50) + 1alm/enc(70x50) + 1alm/rim(50x42)

Módulo 160 - 1ass(110) + 1puff(50) + 1alm/enc(90x50) + 1alm/rim(50x42)

Módulo 230 - 1ass(180) + 1puff(50) + 2alm/enc(70x50) + 2alm/rim(50x42)

Módulo 270 - 1ass(220) + 1puff(50) + 2alm/enc(90x50) + 2alm/rim(50x42)

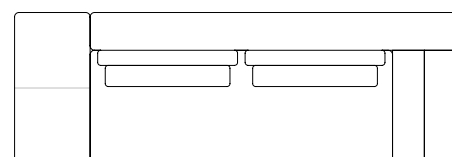

Configurações com 1 assento, 1 braço (55) e 1 braço/mesa

Módulo 283 - 1ass(180) + 1br(55) + 1br/mesa(48) + 2alm/enc(70x50) + 2alm/rim(50x42)

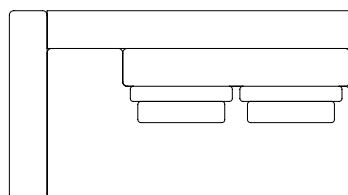

Configurações com 1 assento, 1 puff, 1 braço (25) e 1 mesa no encosto

Módulo 165 - 1ass(90) + 1br(25) + 1puff(50) + 1alm/enc(70x50) + 1alm/rim(50x42)

Módulo 185 - 1ass(110) + 1br(25) + 1puff(50) + 1alm/enc(90x50) + 1alm/rim(50x42)

Módulo 255 - 1ass(180) + 1br(25) + 1puff(50) + 2alm/enc(70x50) + 2alm/rim(50x42)

Módulo 295 - 1ass(220) + 1br(25) + 1puff(50) + 2alm/enc(90x50) + 2alm/rim(50x42)

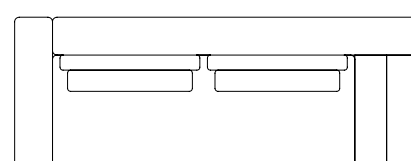

Configurações com 1 assento, 1 braço (25) e 1 braço/mesa

Módulo 253 - 1ass(180) + 1br(25) + 1br/mesa(48) + 2alm/enc(70x50) + 2alm/rim(50x42)

Módulo 293 - 1ass(220) + 1br(25) + 1br/mesa(48) + 2alm/enc(90x50) + 2alm/rim(50x42)

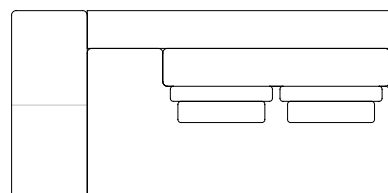

Configurações com 1 assento, 1 puff, 1 braço (55) e 1 mesa no encosto

Módulo 195 - 1ass(90) + 1br(55) + 1puff(50) + 1alm/enc(70x50) + 1alm/rim(50x42)

Módulo 215 - 1ass(110) + 1br(55) + 1puff(50) + 1alm/enc(90x50) + 1alm/rim(50x42)

Módulo 285 - 1ass(180) + 1br(55) + 1puff(50) + 2alm/enc(70x50) + 2alm/rim(50x42)

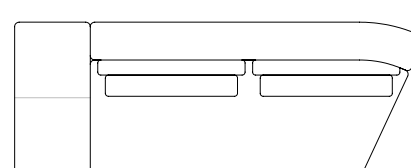

Configurações de 1 assento em ângulo e 1 braço (55)

Módulo 190 - 1ass(90) + 1br(55) + 1alm/enc(100x50) + 1alm/rim(50x42)

Módulo 280 - 1ass(180) + 1br(55) + 2alm/enc(90x50) + 2alm/rim(50x42)

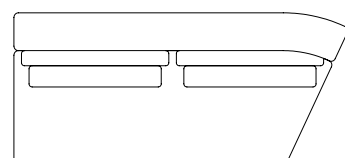

Configurações de 1 assento em ângulo

Módulo 135 - 1ass(90) + 1alm/enc(100x50) + 1alm/rim(50x42)

Módulo 225 - 1ass(180) + 2alm/enc(90x50) + 2alm/rim(50x42)

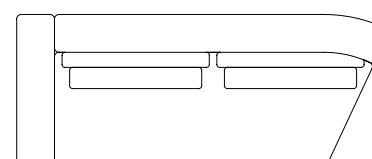

Configurações de 1 assento em ângulo e 1 braço (25)

Módulo 160 - 1ass(90) + 1br(25) + 1alm/enc(100x50) + 1alm/rim(50x42)

Módulo 250 - 1ass(180) + 1br(25) + 2alm/enc(90x50) + 2alm/rim(50x42)

